

Installation Instructions

Ground Fixed

Babel Drum
Page 1 of 3



Instrument Components:



Metric Conversion:
200mm/ 8"
400mm/ 16"
530mm/ 20 55/64"
680mm/ 26 49/64"
700mm/ 27 9/16"
850mm/ 33 15/32"
980mm/ 38 37/64"
1.5m/ 59"

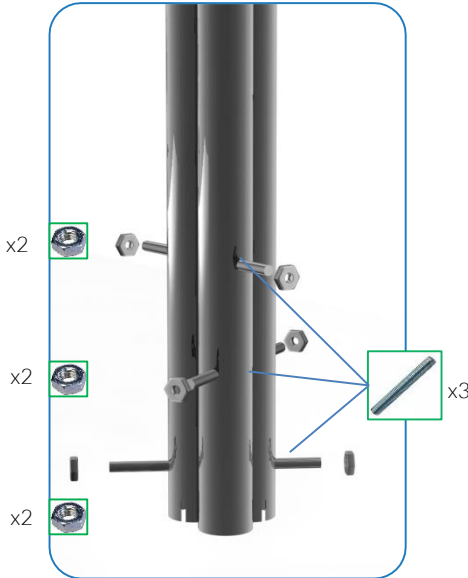

Weight of heaviest part **17.5kg** (Large Babel Drum)
Weight of heaviest part **13.4kg** (Small Babel Drum)

1. Unpack ground fixing legs 3no.

2. Lay packaging out on floor or assemble on non-abrasive surface to prevent marking of polished stainless steel.

3. Align holes on legs (opposite end to polished domes) and secure in place using 3no. M10 x 200mm threaded bar and 6no. M10 nuts provided
Tools required 2no. 17mm metric spanner/wrench (11/16 inch or alternatively using adjustable wrench)

4. Invert assembled frame so domed ends face upwards.

5. Place 8mm Hex Key supplied into hole in leg and lock into internal bolt.

6. Remove Black caps opposite side of leg and keeping Hex Key in place, slide black polyurethane damper over bolt until flush with end of bolt. Repeat for other 2 legs

7. Unpack babel drum leaving black film in place to protect.

8. Align holes in side of babel drum with bolts on legs.

9. Using 8mm Hex Key screw bolts into drum to secure in place.
Use thread locking solution
All hole locations are laser cut for accuracy to ensure holes in drum align perfectly with legs.

10. Using TX40 driver provided secure M8 x 25mm security bolts into external holes in legs 3no. Use thread lock solution

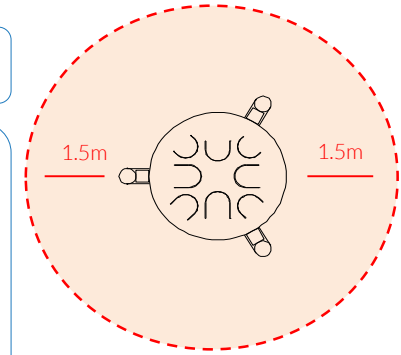

Install Instrument with 1.5m free space (from widest point) around it.

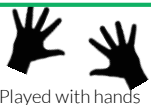
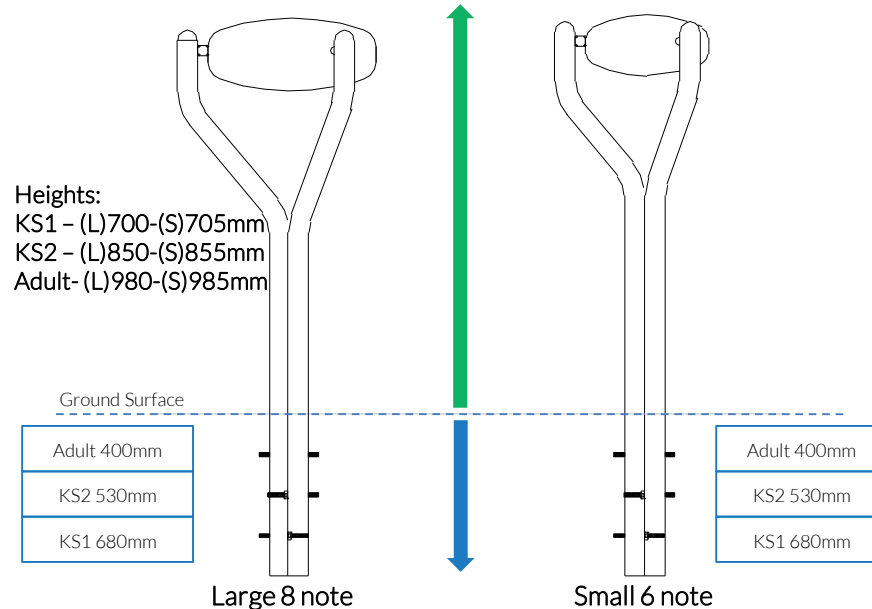

CAUTION: Drum surface can get hot in direct sunlight, if possible install in shaded areas.

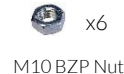

Ground Fix Components:



Tools:

-  x1
Hex T Key
-  x1
TX 40 Driver Bit

Ground Fixed

Babel Drum
Page 2 of 3



Instrument Components:

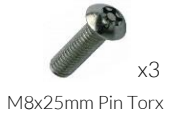

Thread Lock Solution
Required

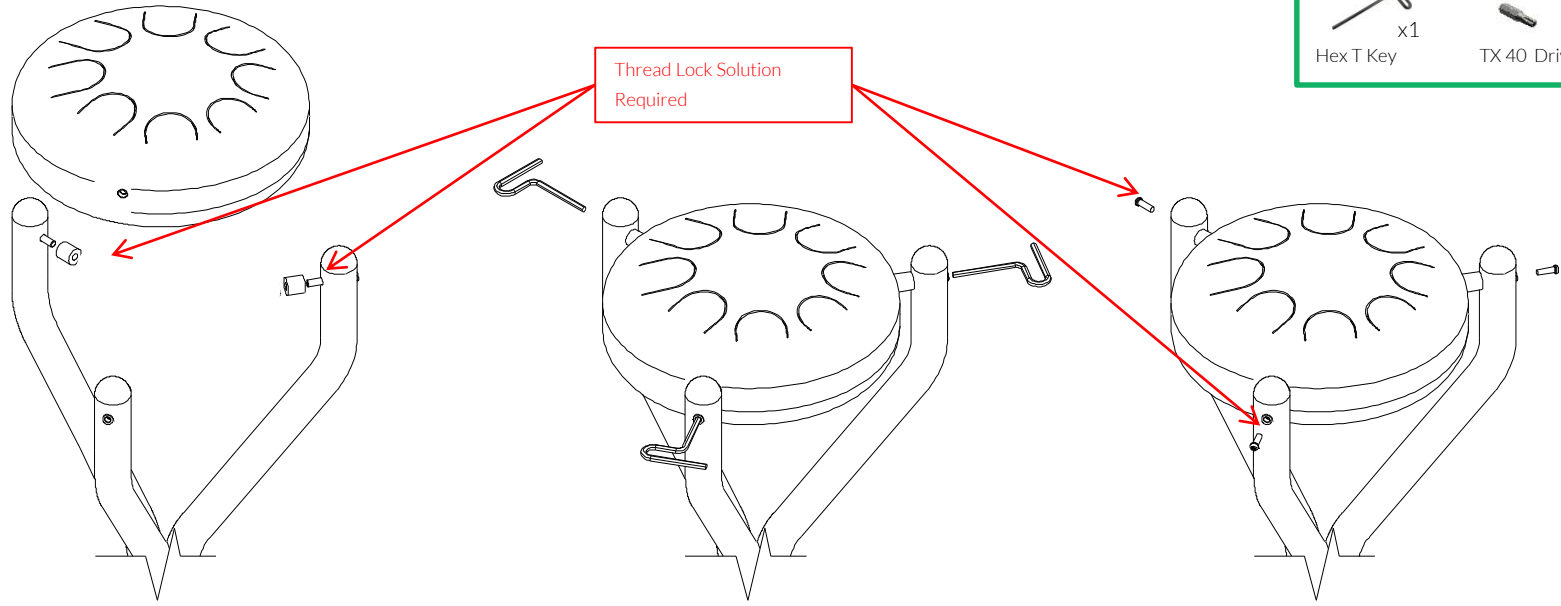

1 2 3

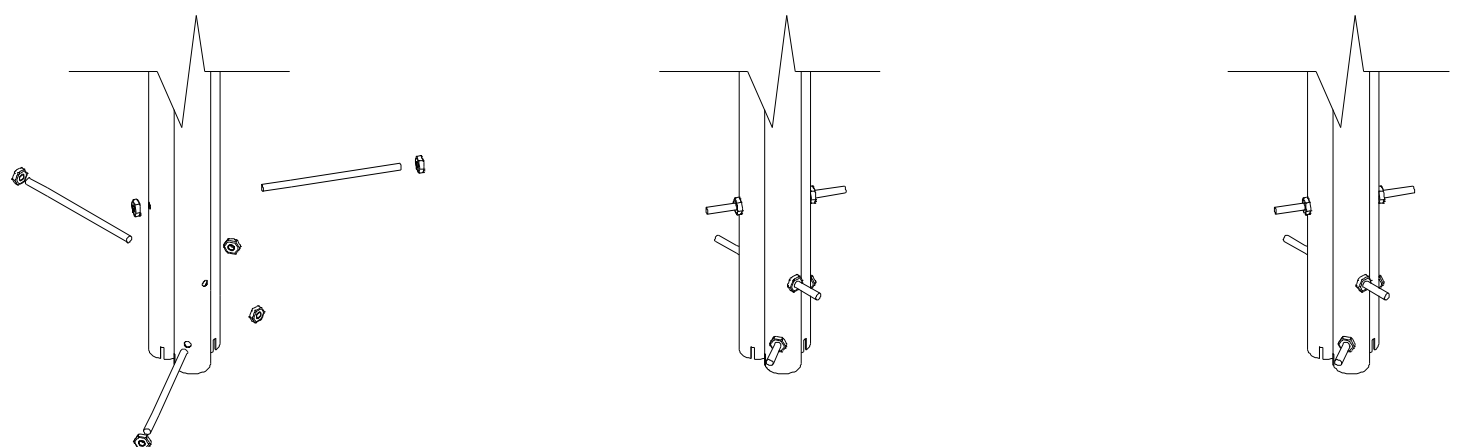

Ground Fix Components:

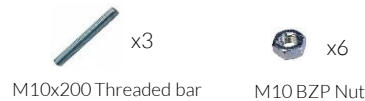

Spares available from
percussionplay.com or from your
local distributor

22 Kg
13.4 Kg

Ground Fix Installation

- 1 Insert M10x 200 Threaded bar into pre drilled holes in Frame of Babel Drum using M10 BZP Nuts
- 2 Excavate a holes with a 250mm diameter tapering down to 350mm diameter and 450mm depth

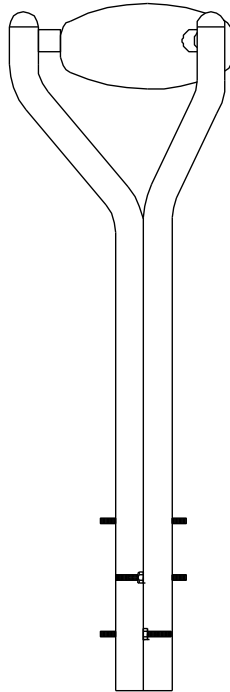
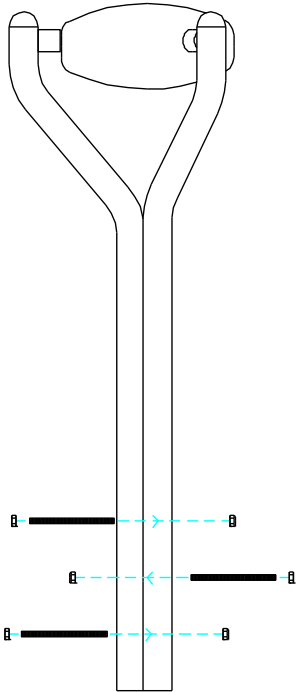

- 3 Compact base of hole with 50mm of aggregate. Lower ground Fix post attached to instrument into hole (check instrument straight and level before filling with concrete)

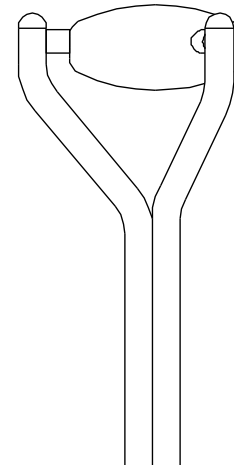

- 4 Fill hole with fast drying concrete to manufacturers specifications.

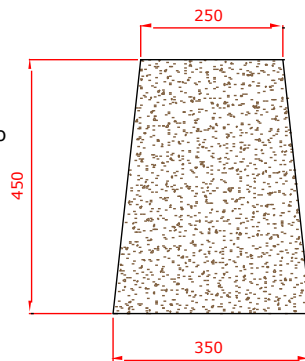
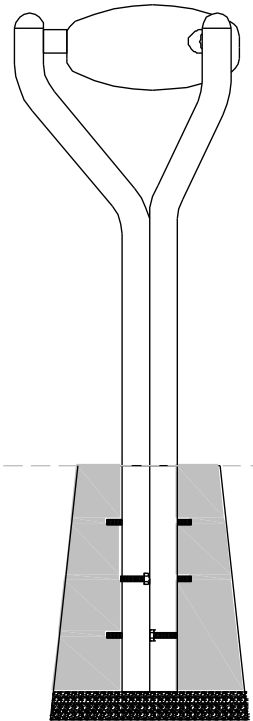

If Drum needs to be positioned lower a deeper hole can be excavated.

Foundations should not present a hazard. These foundations are recommended as a guide, for more information on foundation details for various surface see Part 7 of BS EN 1176.

Ground Fixed

Babel Drum
Page 3 of 3



Components:



Metric Conversion:

50mm/ 2"
250mm/ 10"
350mm/ 14"
400mm/ 16"
450mm/ 18"

Installation Instructions

Ground Fixed

Freechimes
Alto/ Soprano
Page 1 of 4



1. Carefully lay 2 x legs on a level surface and check distance between **legs is equal**. Line up pre drilled holes in the backboards with the holes in legs and ensure the instrument is aligned square with the legs. **Fix in place using M8x40mm screws** supplied (see installation guide)

2. Attach Ground Fixings to base of legs (**See Ground Fix Post Installation Sheet**)

3. Excavate 2 holes on site of installation minimum **500mm deep** (adjust depth according to age range for intended players)

4. Carefully raise the instrument from the ground **with legs attached** and locate (lower) legs **into holes** making sure they are vertical and level prior to concreting in place. (See Ground Fix Sheet)

5. Once happy with location and levels, fill holes using rapid hardening concrete. Be sure to compact concrete around legs and leave to dry according to manufactures guidelines

6. Beaters can be fixed to Steel posts with fixings provided

Install Instrument with 1.5m free space (from widest point) around it.

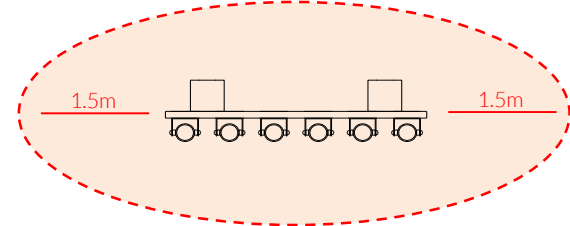

Metric Conversion:
500mm/ 1 ft 7¹¹/₁₆"
900mm/ 2 ft 11⁷/₁₆"
1100mm/ 3 ft 7⁵/₁₆"
1.5m/ 59"

Weight of heaviest part **8.35kg** (Freechimes)

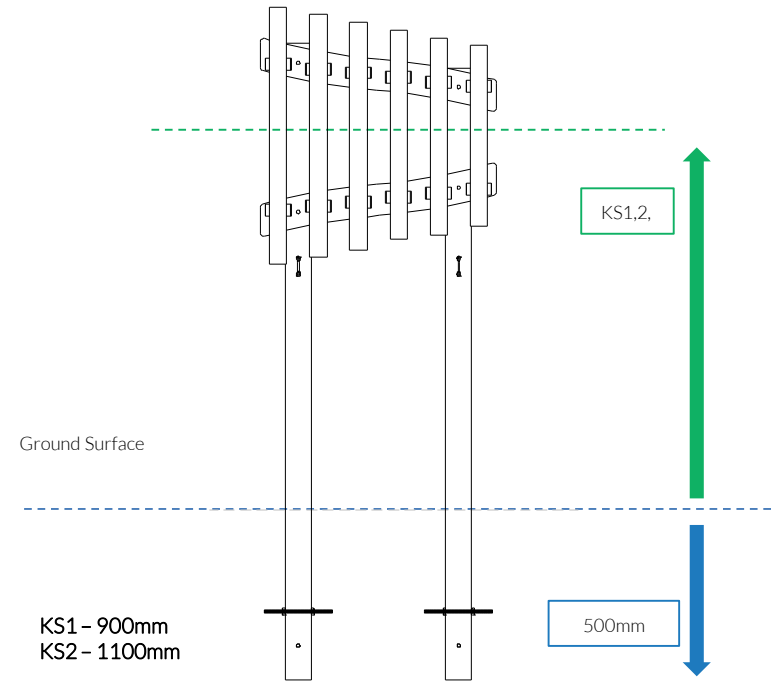

Components:



Pair Small
Beaters X1

Ground Fix
Components:



M10x200 Threaded Bar





M10 Nut

Spares available from
percussionplay.com or from your
local distributor

16 Kg

Assembly Guide PPFREC

Tools:

 x1
 x1





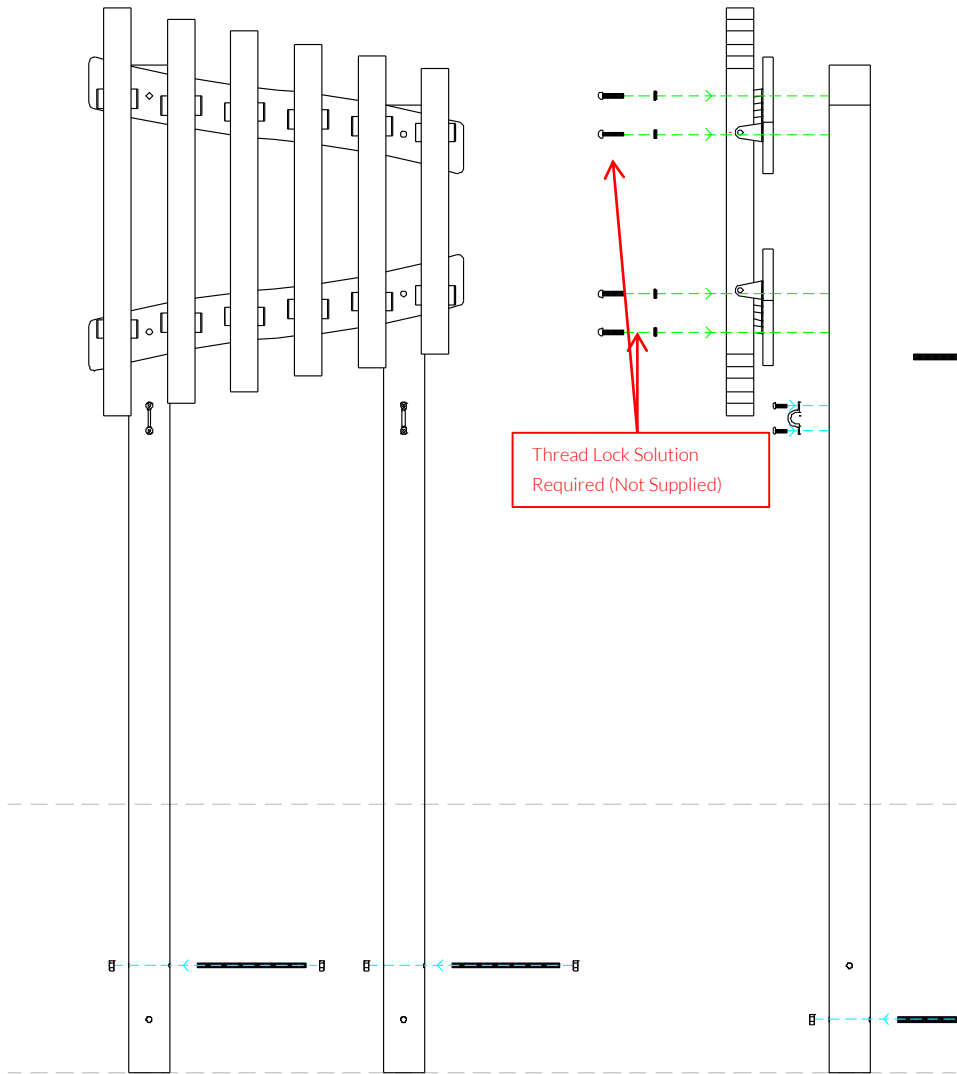

TX 30 Driver Bit TX 40 Driver Bit

Ground Fixed

Freechimes
Alto/ Soprano
Page 2 of 4



COMPONENTS LIST:

-  M10 Nut X8
-  M10x200 Threaded Bar X4
-  Saddle Strap X2
-  M6x20 Pin torx X4
-  M8 Lock washer X4
-  M8x40 Pin torx X4

Thread Lock Solution
Required (Not Supplied)

Components:



Eye Straps
X2



M6x20mm
Secure Screw
X4



M8x40mm
Secure Screw
X4



Pair Small Beaters X1

Ground Fix
Components:

 x4

M10x200 Threaded Bar

 x8

M10 Nut

Spares available from
percussionplay.com or from your
local distributor

16 Kg

Ground Fix Post Installation

Foundations should not present a hazard. These foundations are recommended as a guide, for more information on foundation details for various surface see Part 7 of BS EN 1176.

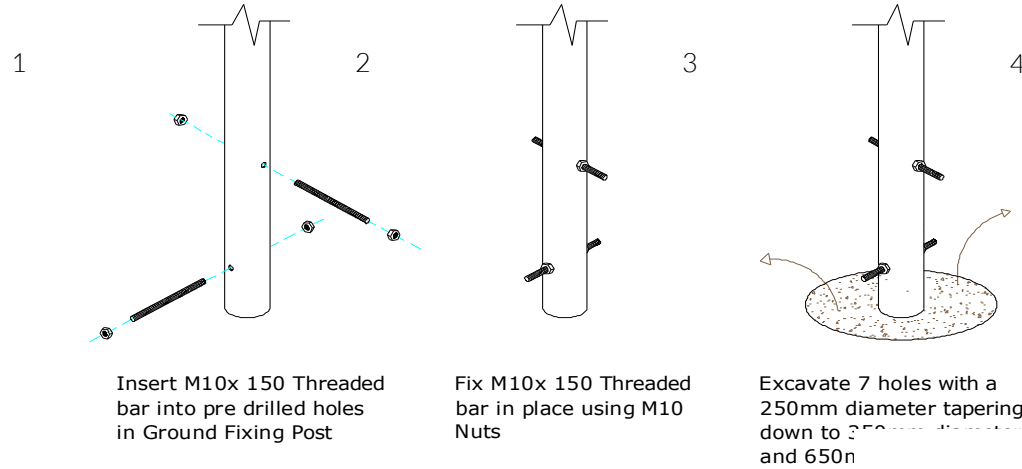

Metric Conversion:	
50mm	2"
100mm	4"
250mm	10"
350mm	14"
500mm	1 ft 7 11/16"
550mm	1 ft 9 21/32"
	"

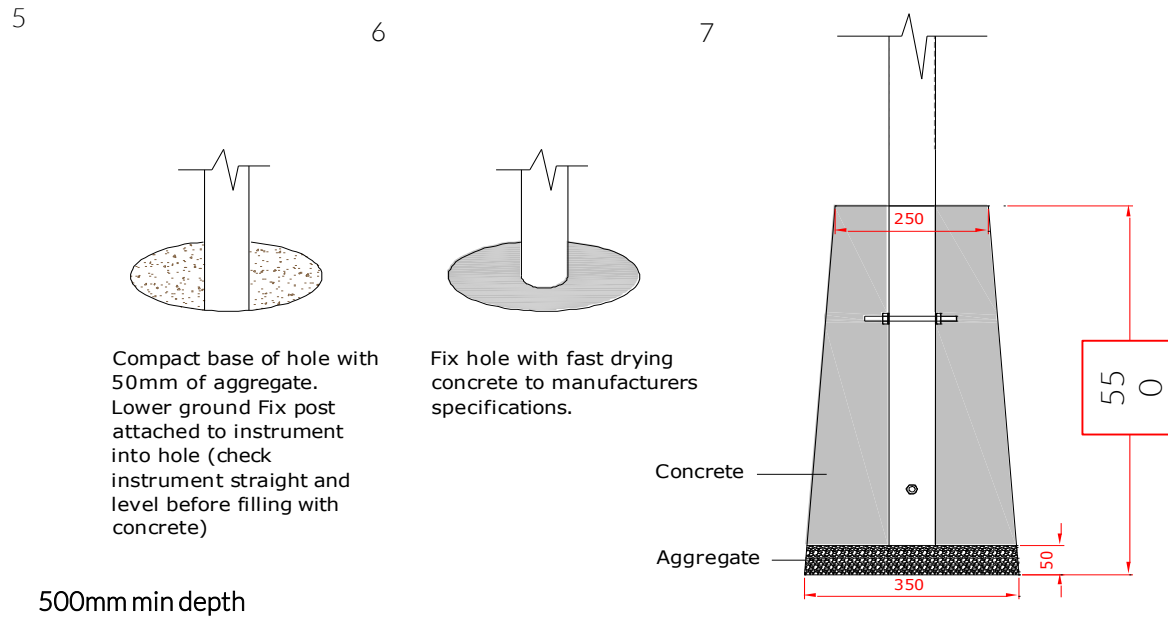

500mm min depth

Ground Fixed

Freechimes
Alto/ Soprano
Page 3 of 4



Components:



x4

M10x200 Threaded Bar



x8

M10 BZP Nut

Thread Lock Solution
Required (Not Supplied)



MADE IN
BRITAIN

BS EN 1176

Foundations should not present a hazard. These foundations are recommended as a guide, for more information on foundation details for various surface see Part 7 of BS EN 1176.

Ground Fixed

Freechimes
Alto/ Soprano
Page 4 of 4



1

Carefully lay 2 x legs on a level surface. Line up pre drilled holes in the backboards with the legs and ensure the instrument is aligned square with the legs. Fix in place using 8x70mm screws supplied

Metric Conversion:

- 50mm/ 2"
- 250mm/ 10"
- 350mm/ 14"
- 500mm/ 1 ft 7 11/16"
- 472mm/ 1 ft 6 37/64"
- 709mm/ 2 ft 3 29/32"

709mm Diatonic Post Centres

472mm Pentatonic Post Centres

2

Excavate 2 holes with a 250mm diameter tapering down to 350mm diameter and minimum 650mm depth

3

Compact base of hole with 50mm of aggregate. Lower ground Fix posts attached to instrument into hole (check instrument straight and level, and at correct height before filling with concrete)

4

Fill holes with fast drying concrete to manufacturers specifications. If posts protrude above instrument they can be cut down

Minimum installation depth required 650mm, to set height of instrument bury deeper until optimum playing height is achieved.

Installation Instructions

Ground Fixed

Congas
Page 1 of 3



Instrument Components:



x4

M10x50 Security Screw



x4

M10x50x3 Square washer



x2

PU 200 Mount



x2

PU 250 Mount

Metric

Conversion:
250mm/ 10"
400mm/ 16"
850mm/ 33"
1.5m/ 59"

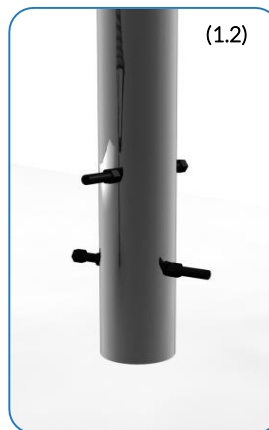
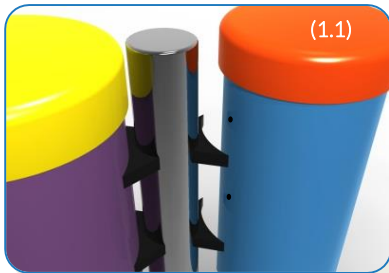

1. Attach the steel leg to each of the congas with the M10x50 security screws, square washers and PU mounts. (1.1) (See Assembly Guide)

2. Attach Ground Fixings to legs (1.2) (See Ground Fix Post Installation Sheet)

3. Excavate 1 hole for the Steel leg 250mm diameter by 300mm deep, in desired location upon decision from customer.

4. Locate (lower) legs into hole making sure they are vertical and level prior to concreting in place.

5. Once happy with location of the Instrument, fill hole using rapid hardening concrete. Be sure to compact concrete around legs and leave to dry according to manufactures guidelines.

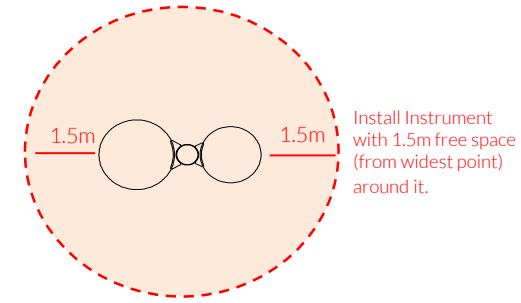

Install Instrument with 1.5m free space (from widest point) around it.

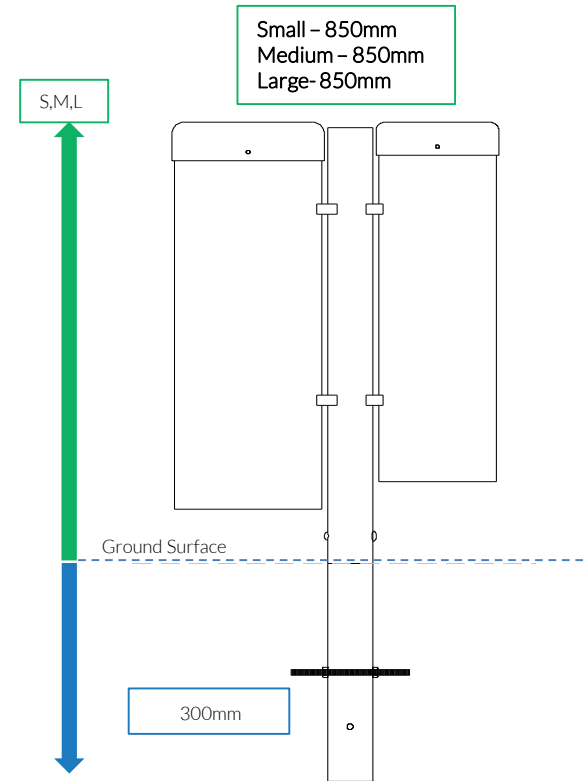

Weight of heaviest part 3.8kg (Large drum Small Congas)
Weight of heaviest part 4.5kg (Large drum Medium Congas)
Weight of heaviest part 5.2kg (Large drum Large Congas)



Played with hands

Ground Fix Components:



x2

M10x200 Bolt



x4

M10 Nut

Assembly Guide PPCONG

Tools:

 x1
TX 45 Driver Bit

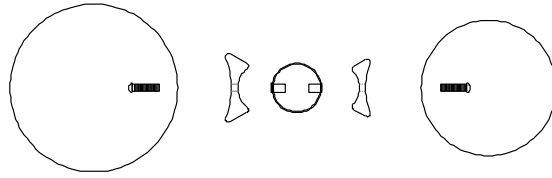

PPCONG PLAN

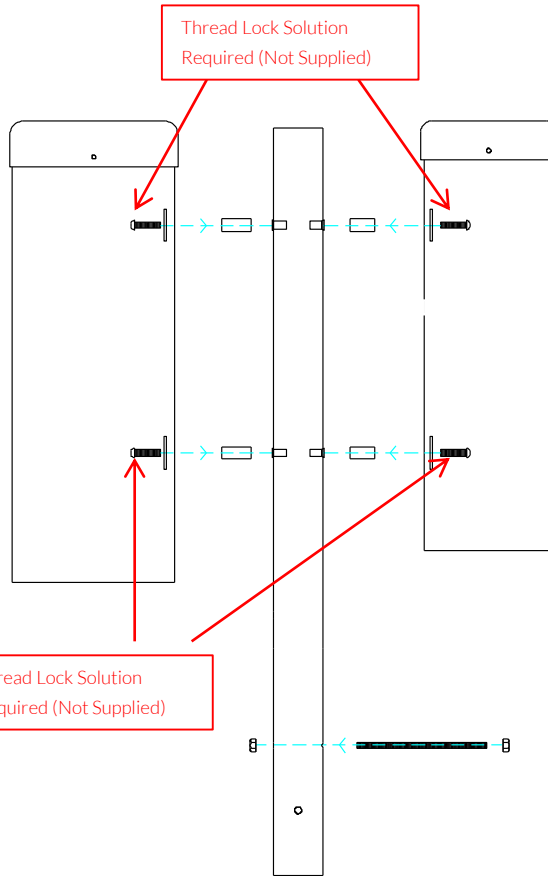





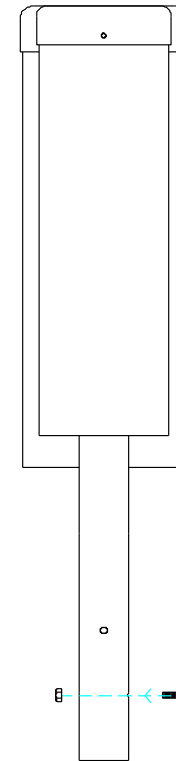

Thread Lock Solution
Required (Not Supplied)

Thread Lock Solution
Required (Not Supplied)



PPCONG SIDE

COMPONENTS LIST:

-  M10x50 Pin torx X4
-  M10x50x3 square washer X4
-  M10 Nut X4
-  M10x200 Threaded Bar X2
-  PU MOUNT 200 X2
-  PU MOUNT 250 X2





PPCONG FRONT

Ground Fixed

Congas
Page 2 of 3



Instrument Components:

-  x4
M10x50 Security Screw
-  x4
M10x50x3 Square washer
-  x2
PU 200 Mount
-  x2
PU 250 Mount

Thread Lock Solution
Required (Not Supplied)



Ground Fix
Components:

-  x2
M10x200 Bolt
-  x4
M10 Nut

Spares available from
percussionplay.com or from your
local distributor

14.8 Kg
15 Kg
20 Kg

Ground Fix Post Installation

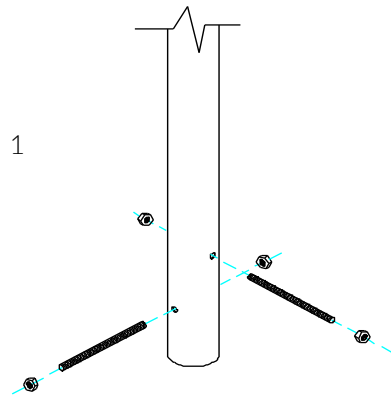

1
Insert M10x 200 Threaded bar into pre drilled holes in Ground Fixing Post

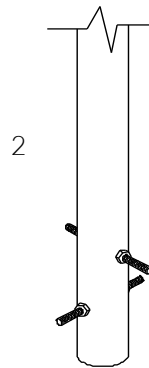

2
Fix M10x 200 Threaded bar in place using M10 Nuts

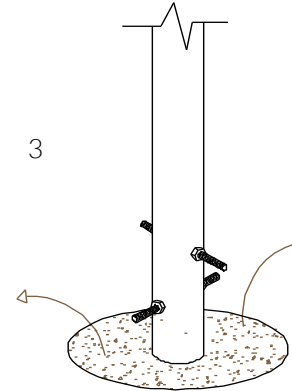

3
Excavate a hole with a 250mm diameter tapering down to 350mm diameter and 350mm depth

Foundations should not present a hazard. These foundations are recommended as a guide, for more information on foundation details for various surface see Part 7 of BS EN 1176.

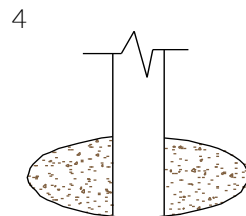

4
Compact base of hole with 50mm of aggregate. Lower ground Fix post attached of instrument into hole (check instrument straight and level before filling with concrete)

300mm min depth

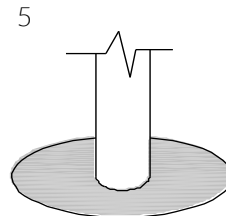

5
Fill hole with fast drying concrete to manufacturers specifications.

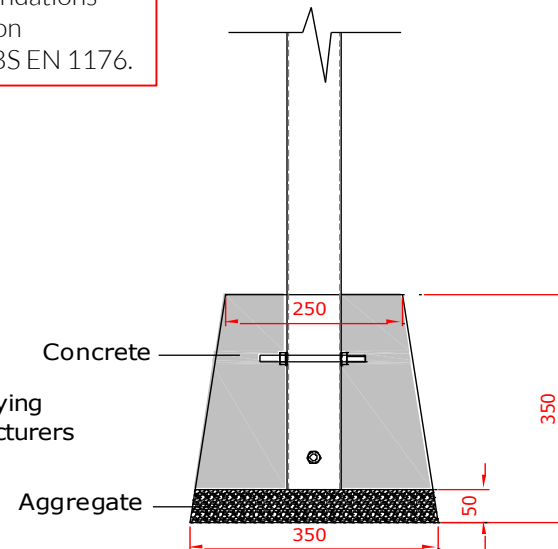

Ground Fixed

Congas
Page 3 of 3



Components:



Metric Conversion:
50mm/ 2"
250mm/ 10"
350mm/ 14"
400mm/ 16"
450mm/ 18"



Installation Instructions



1. Attach the steel legs to the base of the instrument with the M8 Nyloc Nuts and 2 part security caps. (1.1) (See Assembly Guide)

2. Attach Ground Fixing posts to legs (1.2) (See Ground Fix Post Installation Sheet)

3. Excavate 1 hole for the Steel legs **250mm diameter** by **400-550mm deep** depending on Key stage, in desired location upon decision from customer.

4. Locate (lower) legs into holes making sure they are vertical and level prior to concreting in place.

5. Once happy with location of the Instrument, **fill** holes using rapid hardening **concrete**. Be sure to compact concrete around legs and leave to dry according to manufactures guidelines.

6. Attach the 1 pair of beater to the saddle strap on the leg. (1.3)

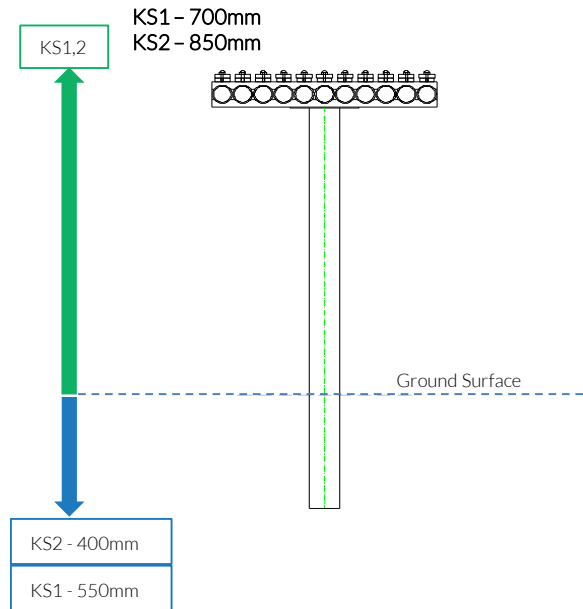
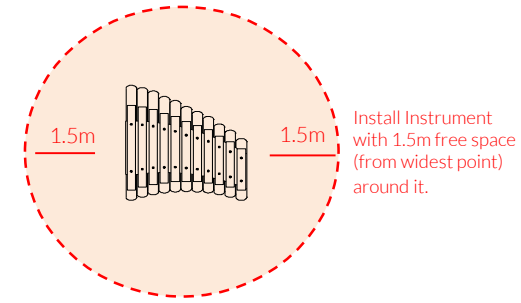

Weight of heaviest part **7kg** (Cadenza)

Ground Fixed

Cadenza
Page 1 of 3

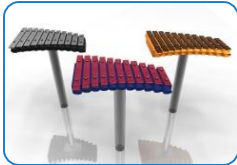

Components:

-  x4
M8 Nyloc Nut
-  x2
M6x20 Security Screw
-  x4
2 Part Cover Cap
-  x1
M6 Saddle Strap

Metric
Conversion:
250mm/ 10"
400mm/ 15 3/4"
550mm/ 21 21/32"
700mm/ 27 9/16"
850mm/ 33 15/32"
1.5m/ 59"



Pair Small Red Beaters X1



Ground Fix Components:

-  x2
M10x200 Bolt
-  x4
M10 Nut

Spares available from
percussionplay.com or from your
local distributor

14 Kg

Tools:

 x1
  x1

TX 30 Driver Bit TX 40 Driver Bit

Ground Fixed

Cadenza
Page 2 of 3

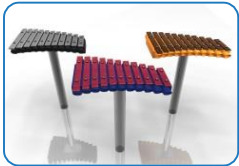





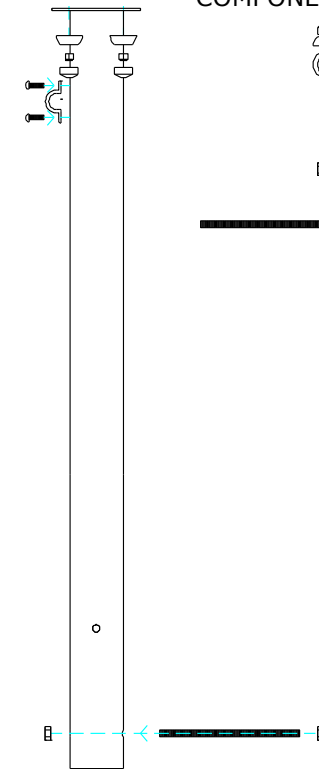
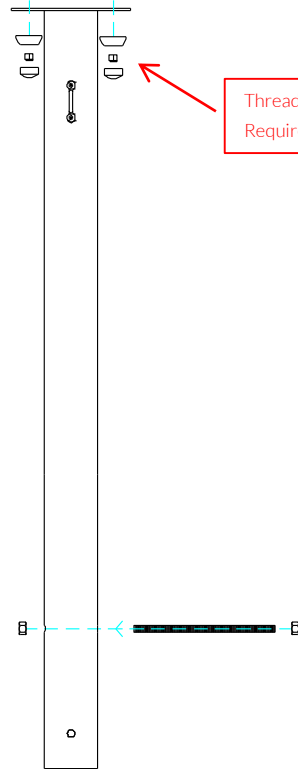
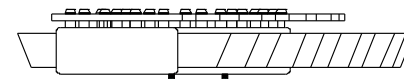
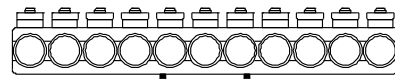

Instrument Components:

-  x4
M8 Nyloc Nut
-  x2
M6x20 Security Screw
-  x4
2 Part Cover Cap
-  x1
Cap
-  x1
M6 Saddle Strap



Thread Lock Solution
Required (Not Supplied)

COMPONENTS LIST:

-  2 Part Cover Cap X4
-  M8 Nyloc nut X4
-  M10 Nut X4
-  M10x200 Threaded Bar X2
-  Saddle Strap X1
-  M6x20 Pin torx X2

PPCADE FRONT

PPCADE SIDE

Thread Lock Solution
Required (Not Supplied)



Pair Small Red Beaters X1

Ground Fix Components:

-  x2
M10x200 Bolt
-  x4
M10 Nut

Spares available from
percussionplay.com or from your
local distributor

14 Kg

Ground Fix Post Installation

Foundations should not present a hazard. These foundations are recommended as a guide, for more information on foundation details for various surface see Part 7 of BS EN 1176.

Ground Fixed

Cadenza
Page 3 of 3

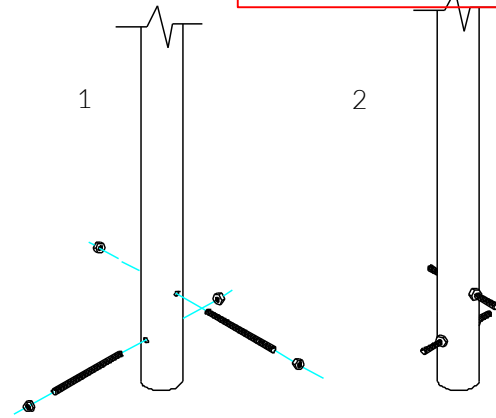
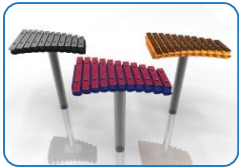

1 Insert M10x 150 Threaded bar into pre drilled holes in Ground Fixing Post

2 Fix M10x 200 Threaded bar in place using M10 Nuts

Components:



Metric Conversion:
50mm/ 2"
250mm/ 10"
350mm/ 14"
400mm/ 16"
450mm/ 18"

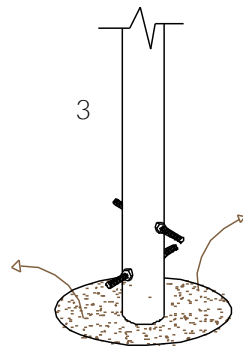

3 Excavate 6 holes with a 250mm diameter tapering down to 350mm diameter and 450mm depth

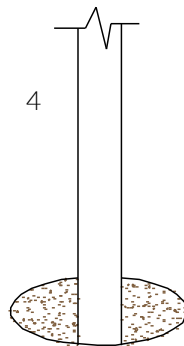

4 Compact base of hole with 50mm of aggregate. Lower ground Fix post attached to instrument into hole (check instrument straight and level before filling with concrete)

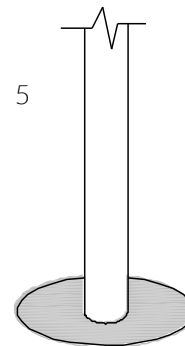

5 Fix hole with fast drying concrete to manufacturers specifications.

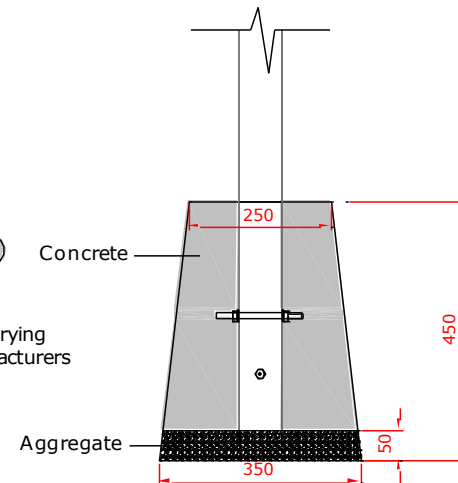

400mm min depth

Ground Fix Installation

Foundations should not present a hazard. These foundations are recommended as a guide, for more information on foundation details for various surface see Part 7 of BS EN 1176.

Ground Fixed

Cherub
Page 3 of 3

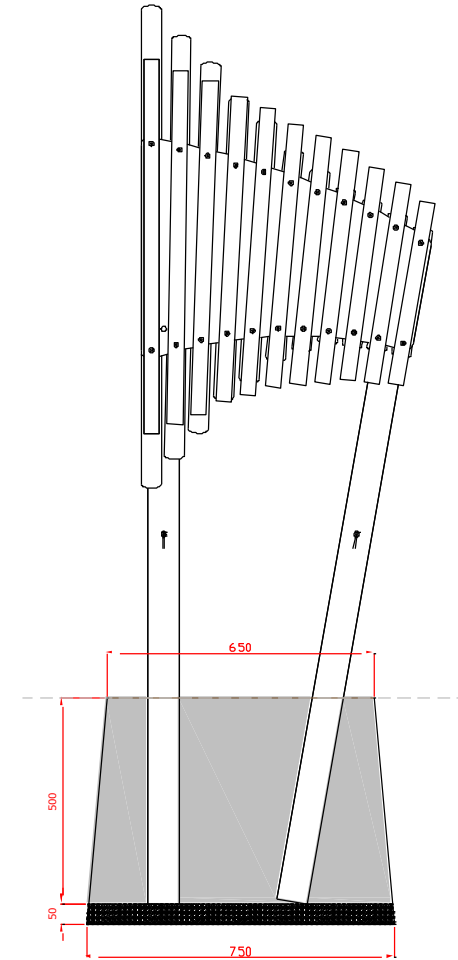
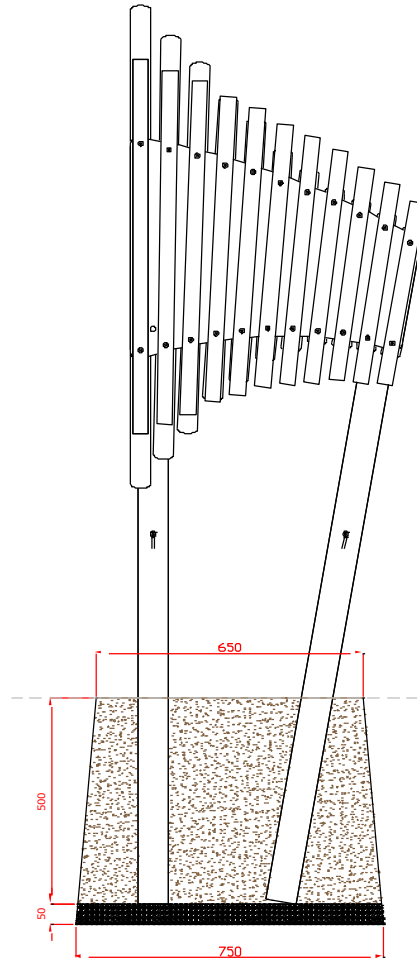
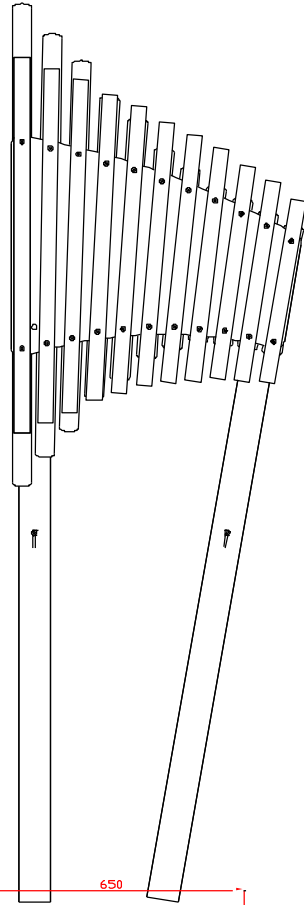

Components:



M10x200mm
BZP Bar
X4



M10 BZP Nut
X8

Metric Conversion:

50mm/ 2"
250mm/ 10"
350mm/ 14"
500mm/ 1 ft 7 11/16"
650mm/ 2 ft 1 19/32"

1

Excavate a hole with a 250x650mm tapering down to 350x750mm diameter and 550mm depth

500mm min depth - Max depth 700mm

2

Compact base of hole with 50mm of aggregate. Lower ground fix posts attached to instrument into hole (check instrument straight and level, and at correct height before filling with concrete)

3

Fill hole with fast drying concrete to manufacturers specifications. If posts protrude above instrument they can be cut down