

0817

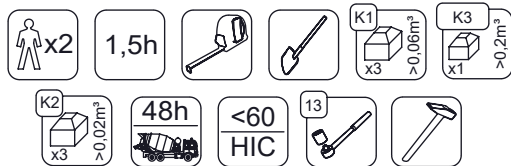

v011
14.06.2021
A. H.
[cm]

vinci
play

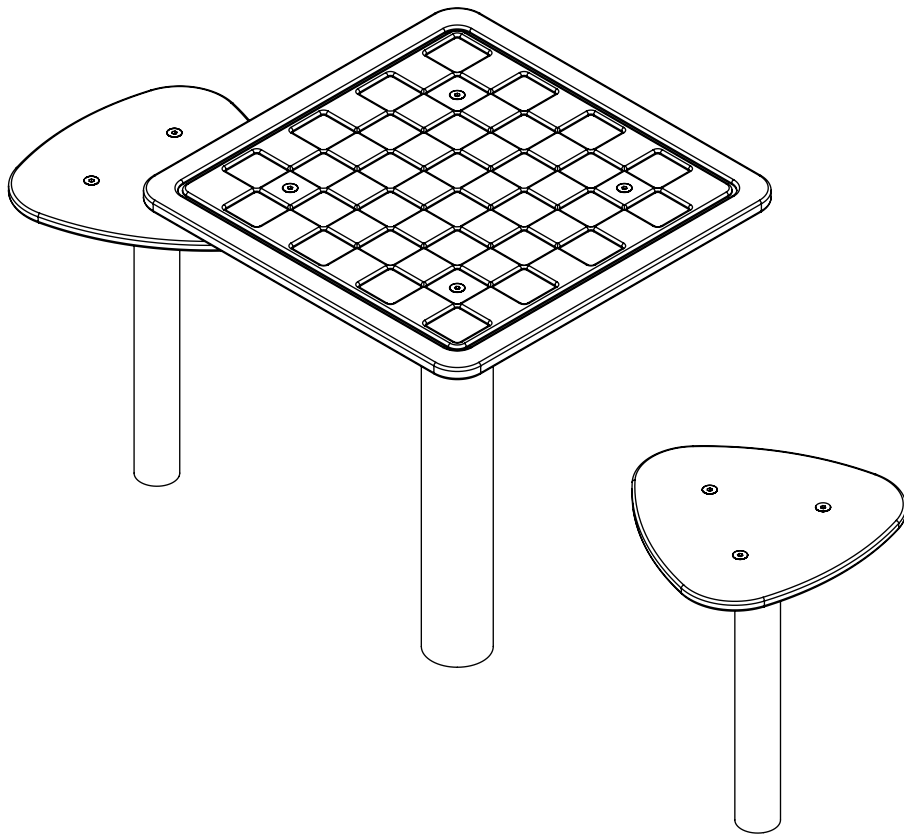
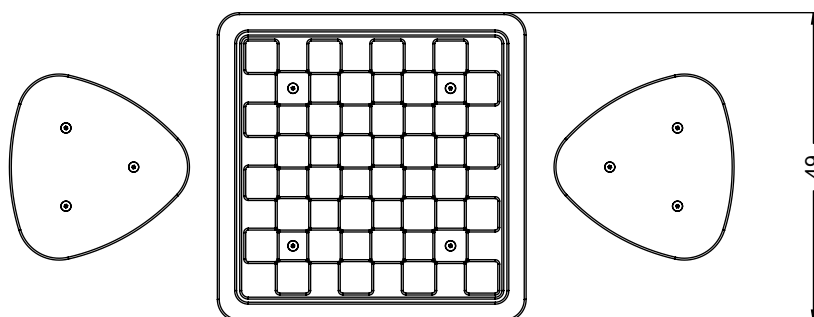
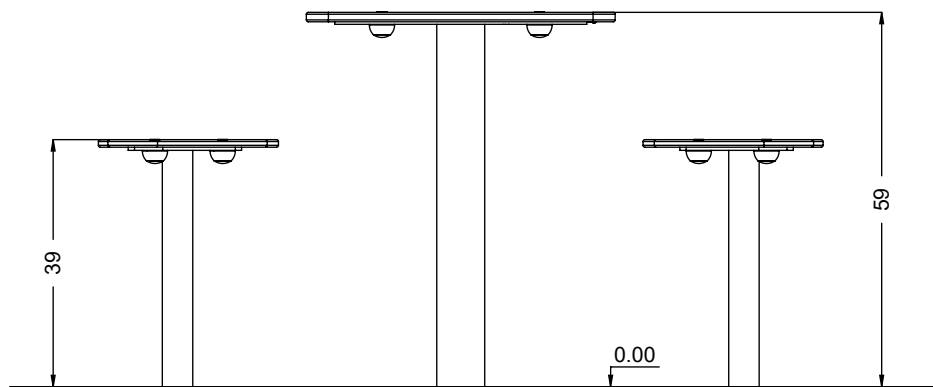

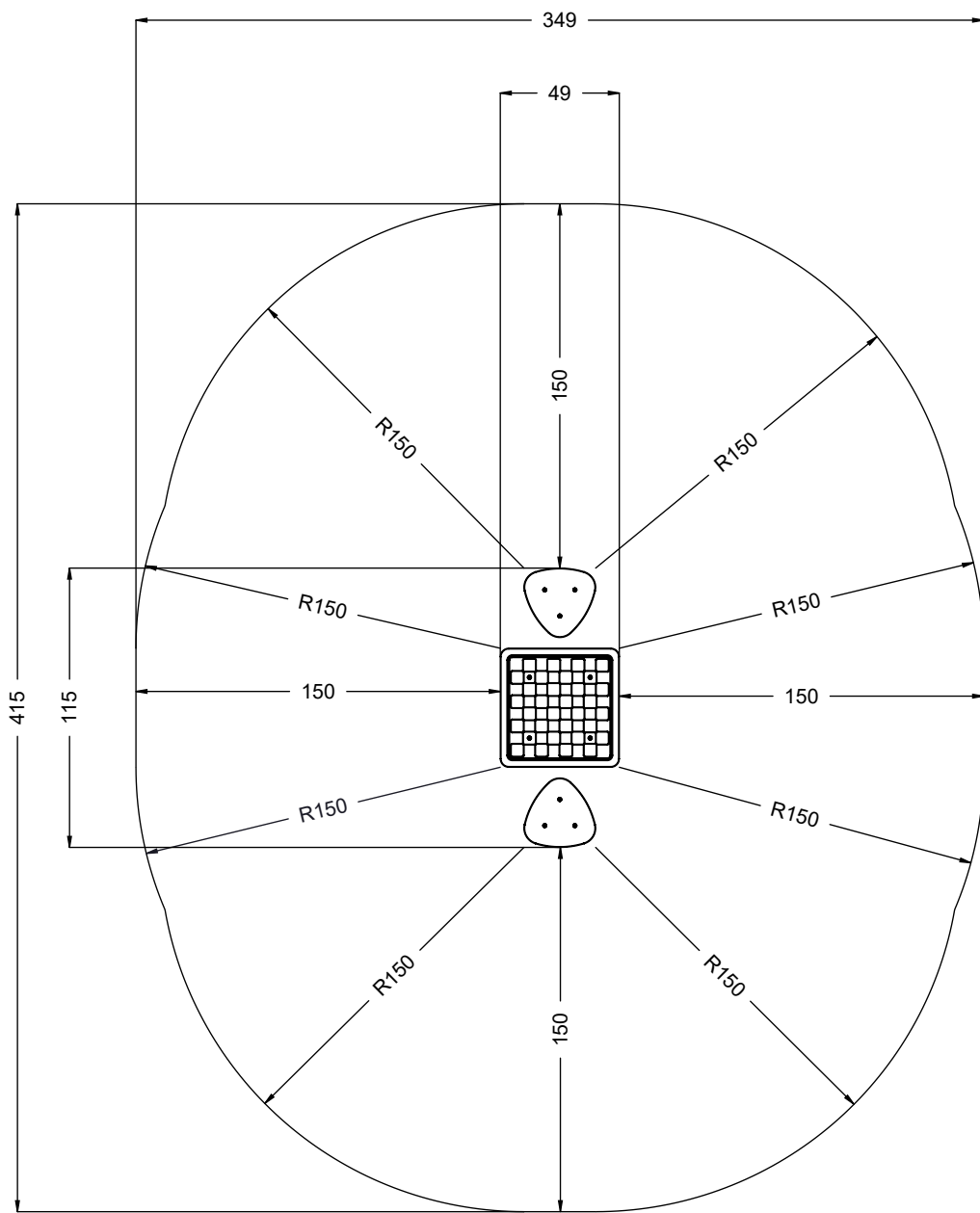

[cm]



vinci
play

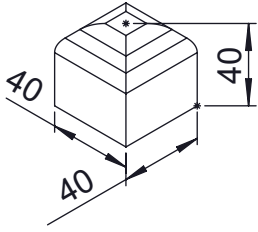

A.

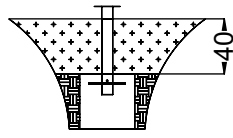

B.

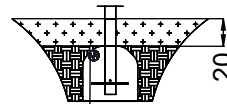

C.

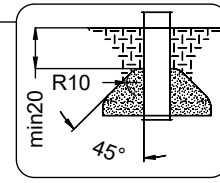
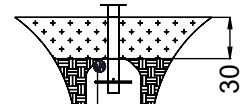

K1

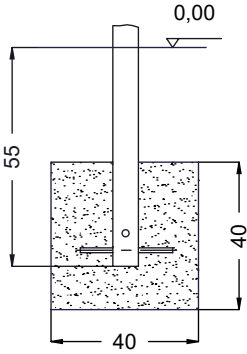

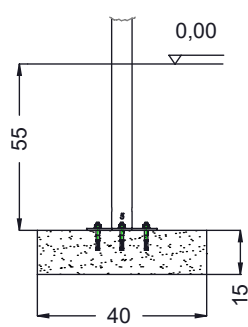

K2

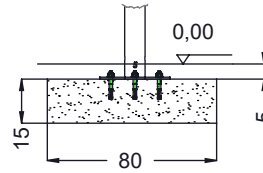

K3



	K2, K3
M10x120 x10	
NOT INCLUDED	

K1 K2

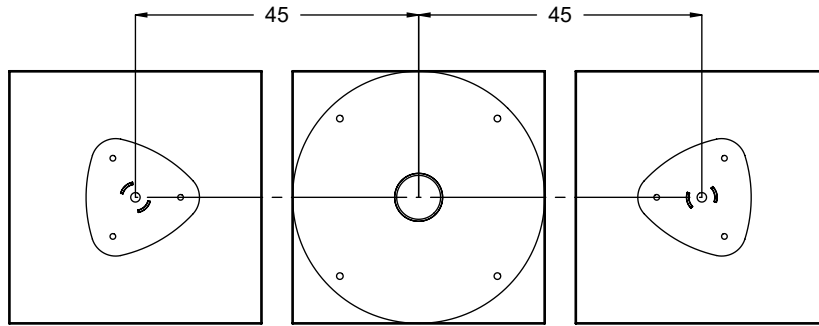

K3

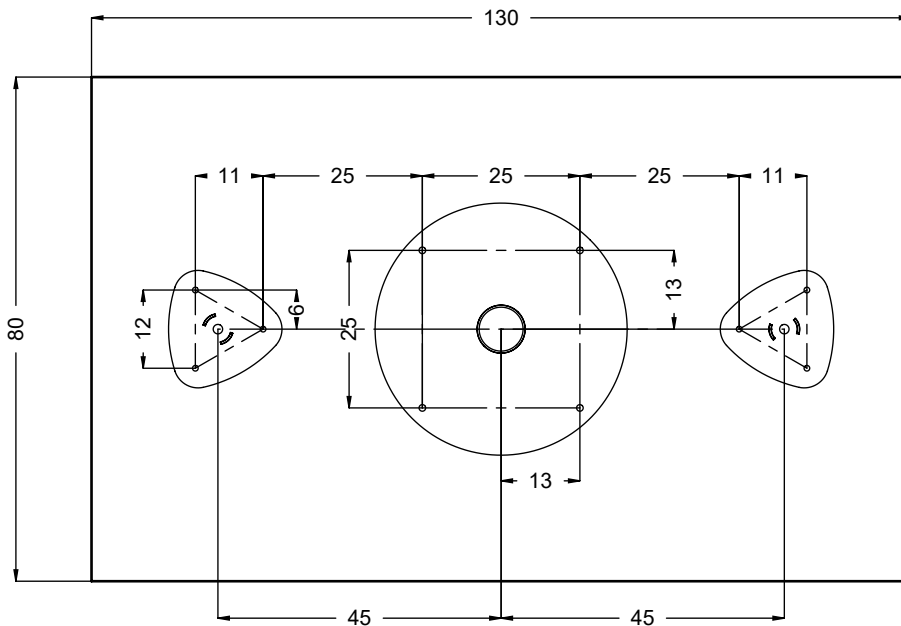

[cm]

 x2	1,5h			48h	 K1 x3 >0.06m³	 K3 x1 >0.2m³	 K2 x3 >0.02m³
----------------------------------------------------------------------------------------	------	-------------------------------------------------------------------------------------	-------------------------------------------------------------------------------------	-----	------------------------------------------------------------------------------------------------------	------------------------------------------------------------------------------------------------------	--------------------------------------------------------------------------------------------------------

vinci
play

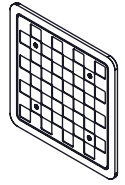
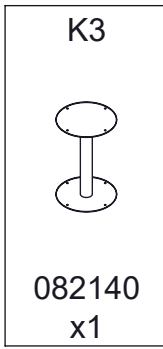
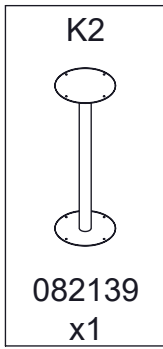
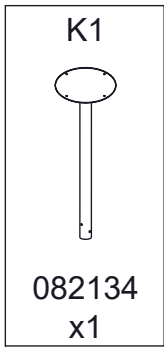
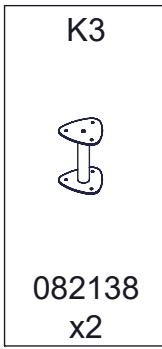
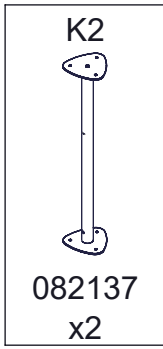
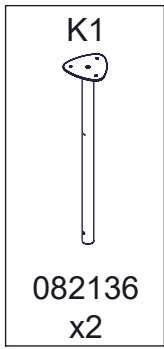

		HDPE		HPL	
1x	V001	1x	CE44	1x	CE44
		2x	CE47	2x	CL47

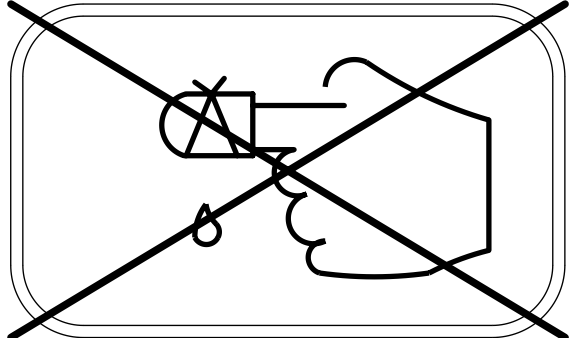
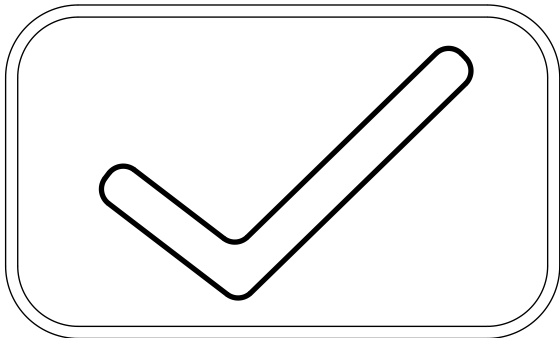
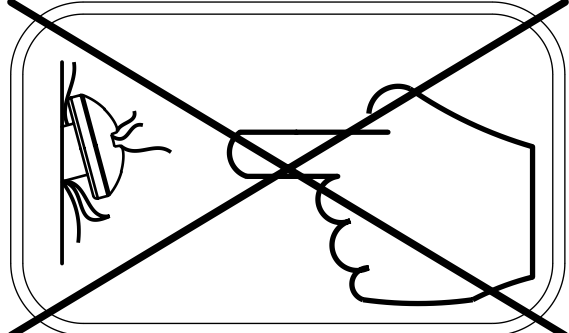
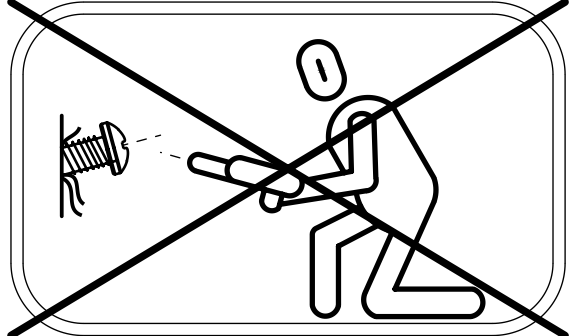

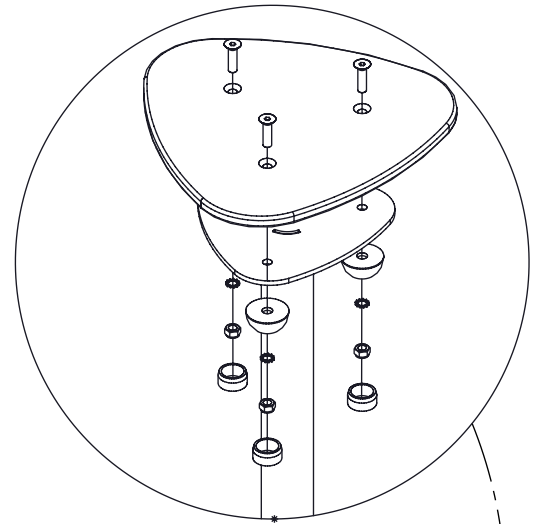
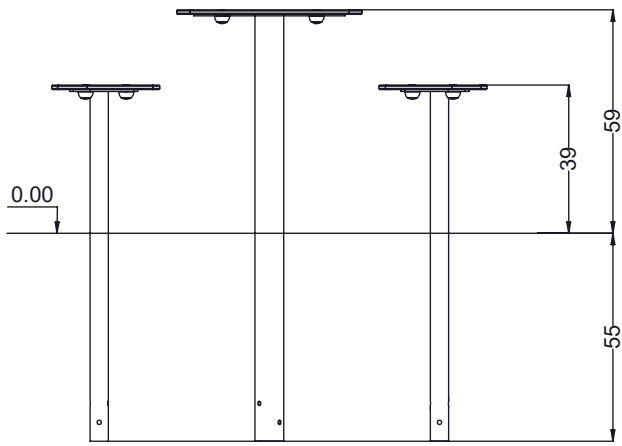

CE44  CL47

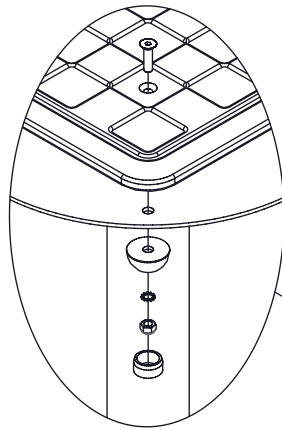

CE44

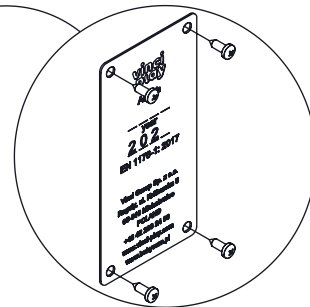
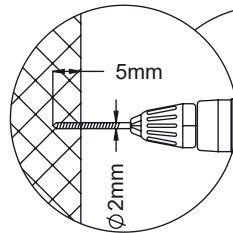
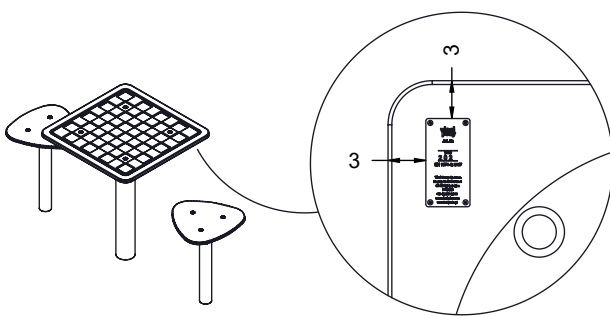
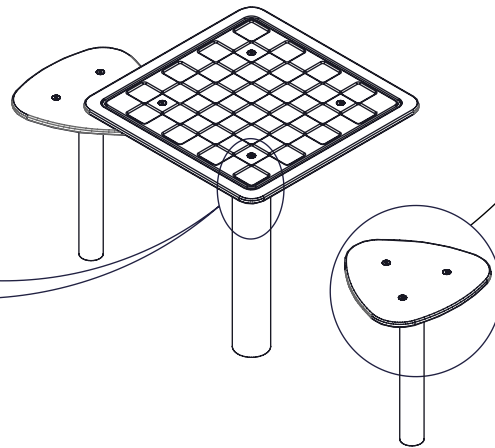

V001

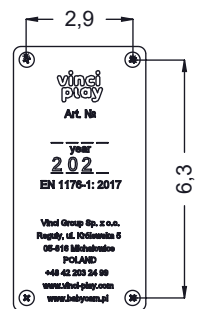

[cm]



vinci
play